



# DM0412/DM0412P 4 – 12 GHz RF Matched Schottky Detector

## FEATURES

- ❖ Excellent Flatness vs. Frequency
- ❖ Excellent Input RF Matching
- ❖ Mounting Holes Option
- ❖ No Bias Required
- ❖ High Sensitivity



## SPECIFICATIONS

4 – 12 GHz RF Matched Schottky Detector		
Parameter	Negative Polarity	Positive Polarity
Model Number	DM0412	DM0412P
Frequency Range	4 – 12 GHz	4 – 12 GHz
Sensitivity	600 mV/mW Min.	550 mV/mW Min.
Flatness vs. Frequency	±0.6 dB Max.	±0.6 dB Max.
RF Input VSWR	1.30:1 Max.	1.35:1 Max.
TSS	-40 dBm Typ.	-40 dBm Typ.
Maximum Input Power	+20 dBm	+20 dBm
Output Polarity	Negative	Positive
Connector Type	SMA Female	SMA Female

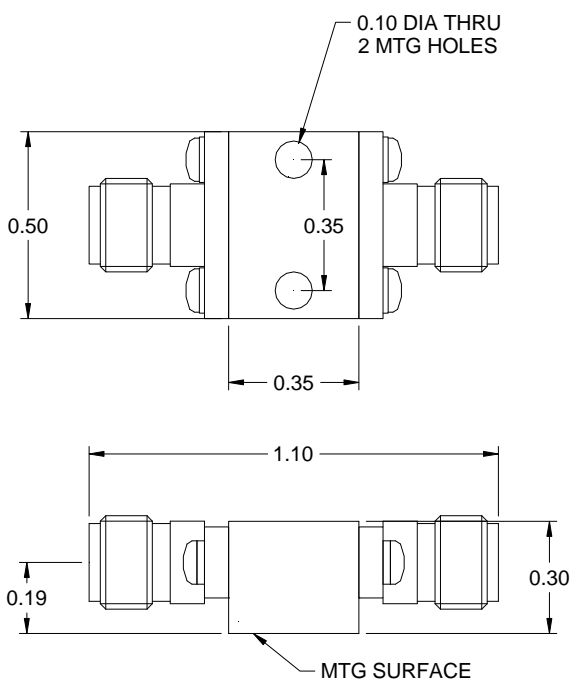

Design to meet the following environmental ratings: (verification optional)

1. Operating Temp: -55°C to +85°C
2. Storage Temp: -65°C to +125°C
3. Shock: MIL-STD-202F, M213, Cond B
4. Altitude: MIL-STD-202F, M105, Cond B
5. Vibration: MIL-STD-202F, M204, Cond B
6. Thermal Shock: MIL-STD-202F, M107, Cond A
7. Temp. Cycle: MIL-STD-202F, M105C, Cond D

Standard Finishing: Rugged Aluminum Housing. Optional finishing with blue epoxy paint per MIL-C-22750 available on request to meet the humidity specification MIL-STD-202F, M103, Cond B

Note:

1. The standard connector is SMA female, other connector available on request
2. The sensitivity is measured into an open circuit load (>10k Ohm)
3. Other frequency range available on request